



SABIANA
IL CLIMA AMICO





STRIEBIG HATTEN 4 & 5 - ENTREPOT DE STOCKAGE - HATTEN 67



DUCK-STRIP

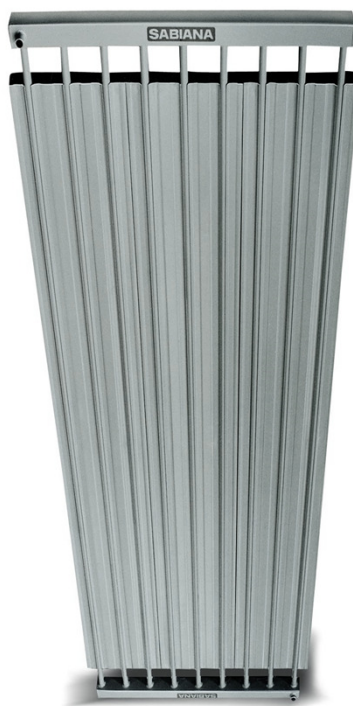

DUCK-STRIP

*Projet : STRIEBIG HATTEN 4 & 5 - ENTREPOT DE
STOCKAGE - HATTEN 67*

Activité : Industrie

Produit : Duck-strip

Quantité : 16 888 ml

Période : 2020 - 2023

BET : LOUISE ADELE

Installateur : GCE



USINE GUSTAVE RIDEAU - LA ROCHE SUR YON 85



DUCK-STRIP

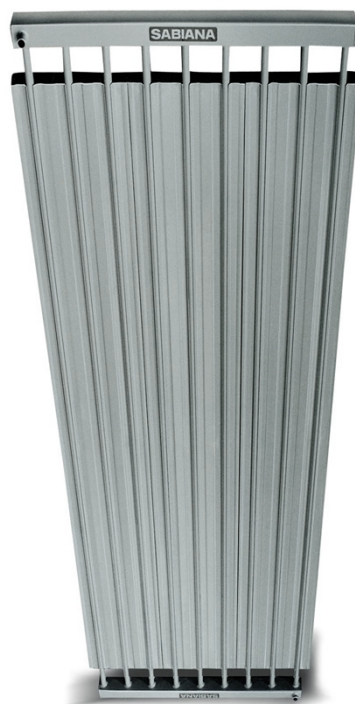

DUCK-STRIP

*Projet : Usine Gustave Rideau - LA ROCHE SUR YON 85
Activité : Industrie
Produit : Duck-strip
Quantité : 414 ml
Période : 2021
Installateur : SITEC*



BATIMENT LOGISTIQUE ITH PASSERELLES HERMES - PIERRE BENITE 69



DUCK-STRIP

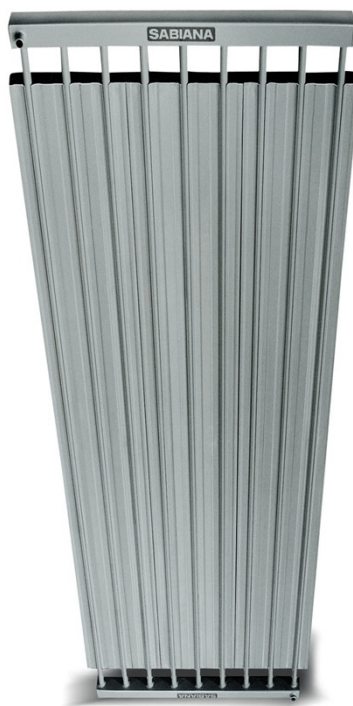

DUCK-STRIP

*Projet : BATIMENT LOGISTIQUE ITH PASSERELLES
HERMES - PIERRE BENITE 69*

Activité : Industrie

Produit : Duck-strip

Quantité : 344 ml

Période : 2021

BET : CETRALP

Installateur : MOOS



MULTIFORM - LA COLOMBE 50



DUCK-STRIP

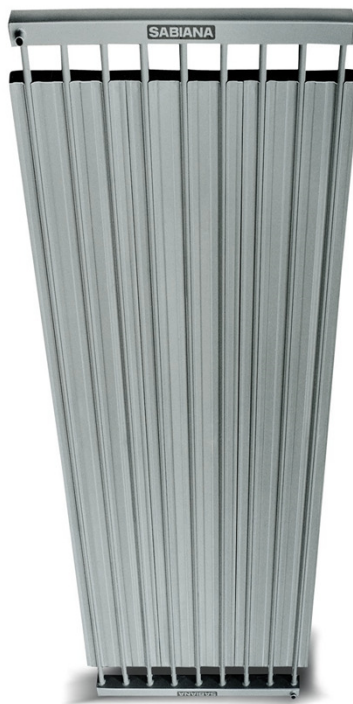

DUCK-STRIP

Projet : MULTIFORM - LA COLOMBE 50

Activité : Industrie

Produit : Duck-strip

Quantité : 336 ml

Période : 2021

BET : ALAIN LENESLAY

Installateur : DOUBLET



BATIMENT SEMAD - ARQUES LA BATAILLE



Projet : Bâtiment Semad - ARQUES LA BATAILLE 76
Activité : Industrie
Produit : Pulsar
Quantité : 319 ml
Période : 2014
BET : EGIS BATIMENT CENTRE OUEST
Installateur : MISSENERD CLIMATIQUE



PLATEFORME SPORTIVE LA SEIGNEURIE - ST CANNAT



DUCK-STRIP



DUCK-STRIP

Projet : PLATEFORME SPORTIVE LA SEIGNEURIE - ST CANNAT 13

Activité : Industrie

Produit : Duck-strip

Quantité : 298 ml

Période : 2020-2021

Installateur : SOGITEC



ADAPEI - REUMUR CHARTRES



DUCK-STRIP

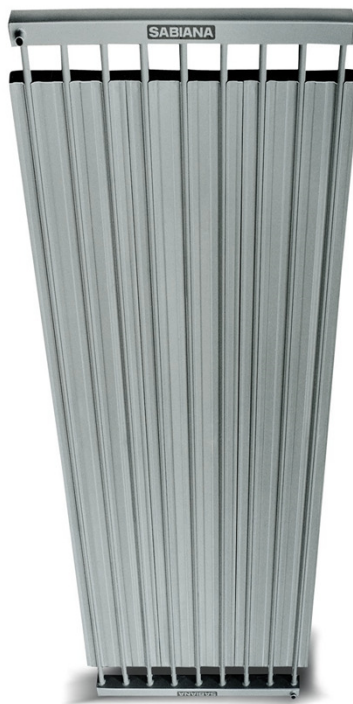

DUCK-STRIP

Projet : ADAPEI - REUMUR – CHARTRES 28
Activité : Industrie
Produit : Duck-strip
Quantité : 288 ml
Période : 2020
BET : EDEIS
Installateur : ACR DISTRIBUTION

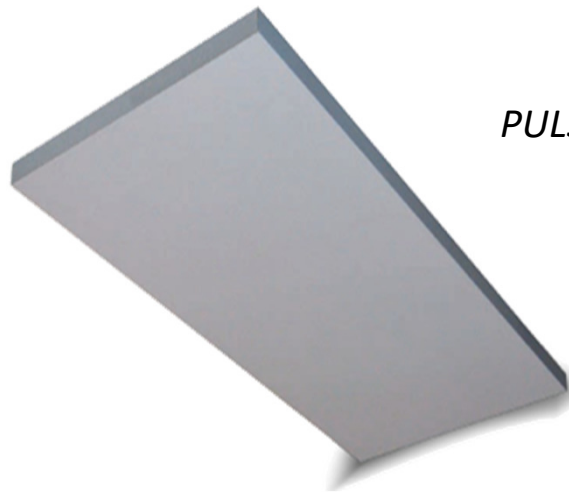

PULSAR

Projet : CDAS 2019 - RENNES 35

Activité : Industrie

Produit : Pulsar

Quantité : 272 ml

Période : 2021

BET : AUA STRUCTURES

Installateur : DOUBLET



MOBILWOOD - ST BRIS LE VINEUX 89



DUCK-STRIP



DUCK-STRIP

Projet : MOBILWOOD - ST BRIS LE VINEUX 89

Activité : Industrie

Produit : Duck-strip

Quantité : 224 ml

Période : 2020

BET : 3IA & SETI

Installateur : MASSON



LES PAPETERIES EMIN LEYDIER - LAVEYRON 26



DUCK-STRIP



DUCK-STRIP

Projet : LES PAPETERIES EMIN LEYDIER - LAVEYRON 26
Activité : Industrie
Produit : Duck-strip
Quantité : 204 ml
Période : 2019 - 2020
Installateur : CAVIFROID



CIFAM 2 - STE LUCE SUR LOIRE



DUCK-STRIP

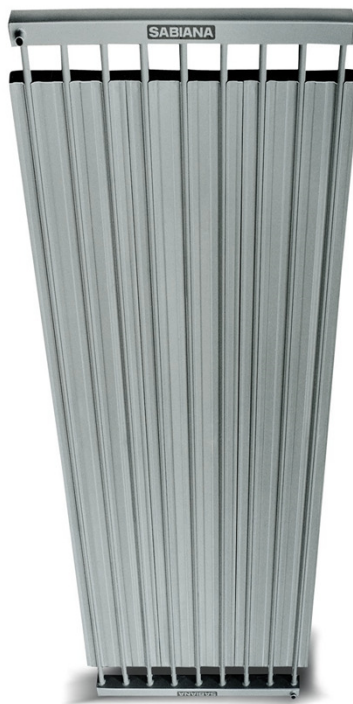

DUCK-STRIP

Projet : CIFAM 2 - STE LUCE SUR LOIRE

Activité : Industrie

Produit : Duck-strip

Quantité : 189 ml

Période : 2021

BET : OTEIS ISATEG

Installateur : ALCIA GENIE CLIMATIQUE



MINDEF CORDERIE - TOULON



DUCK-STRIP

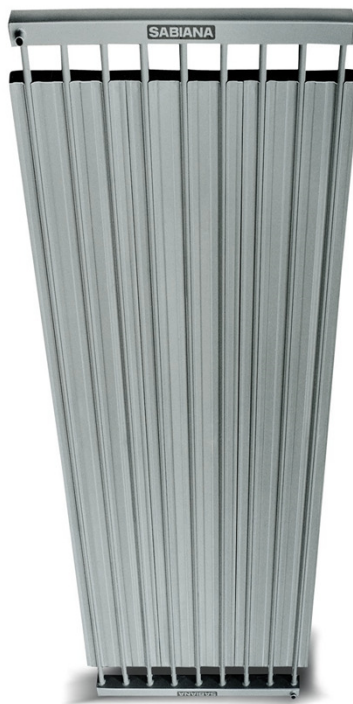

DUCK-STRIP

Projet : Mindef Corderie – TOULON 83

Activité : Industrie

Produit : Duck-strip

Quantité : 158 ml

Période : 2020

BET : /

Installateur : SNEF LA SEYNE SUR MER



EXTENSION D'UN BATIMENT INDUSTRIEL – USINE SOMAC - LA SOUTERRAINE 23



DUCK-STRIP



DUCK-STRIP

*Projet : EXTENSION D'UN BATIMENT INDUSTRIEL –
USINE SOMAC - LA SOUTERRAINE 23
Activité : Industrie
Produit : Duck-strip
Quantité : 114 ml
Période : 2021
BET : BETEM CENTRE
Installateur : SNEF LA SEYNE SUR MER*



BATIMENT USID BAN - LANDIVISAU 29



DUCK-STRIP



DUCK-STRIP

Projet : BATIMENT USID BAN - LANDIVISAU 29

Activité : Industrie

Produit : Duck-strip

Quantité : 106 ml

Période : 2020

BET : ATIS

Installateur : TECHNI CHAUFFAGE



BAT. DE STOCKAGE - SAINT NOLFF 56



DUCK-STRIP



DUCK-STRIP

*Projet : BAT. DE STOCKAGE - SAINT NOLFF 56
Activité : Industrie
Produit : Duck-strip
Quantité : 96 ml
Période : 2020
Installateur : ROQUET G.*



RAM - POTIGNY 14

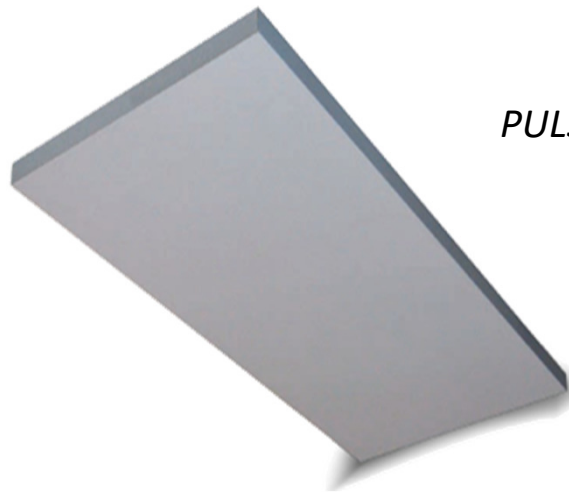

PULSAR

*Projet : RAM - POTIGNY 14
Activité : Industrie
Produit : Pulsar
Quantité : 72 ml
Période : 2021
BET : DELTA FLUIDES
Installateur : SCF*

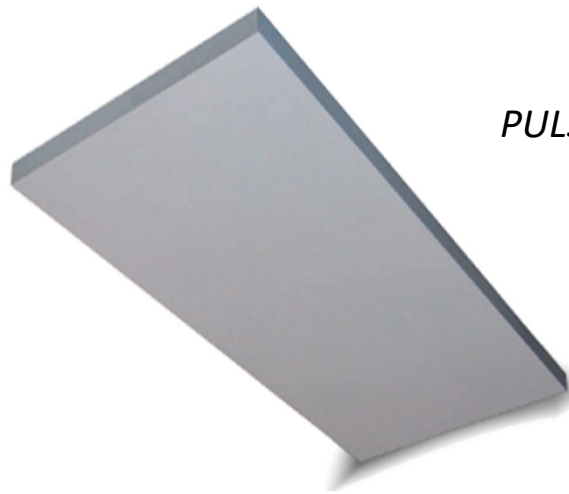

PULSAR

Projet : Trait d'Union - VENDIN LE VIEIL 62
Activité : Industrie
Produit : Pulsar
Quantité : 70 ml
Période : 2020
BET : ETNAP/OPTERE
Installateur : EFFET D'O



HANGAR SANTI - MARSEILLE



DUCK-STRIP



DUCK-STRIP

Projet : Hangar Santi - MARSEILLE 13
Activité : Industrie
Produit : Duck-strip
Quantité : 60 ml
Période : 2020
Installateur : ENERGETIQUE SANITAIRE



MENUISERIE CENTRE TECHNIQUE - BALZAC 38



DUCK-STRIP

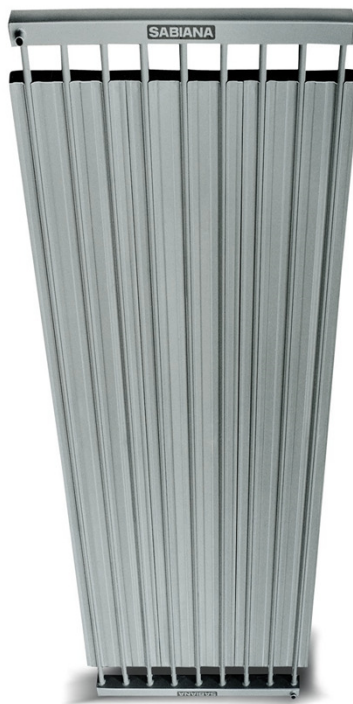

DUCK-STRIP

Projet : MENUISERIE CENTRE TECHNIQUE - BALZAC 38
Activité : Industrie
Produit : Duck-strip
Quantité : 60 ml
Période : 2021
BET : VILLE DE GRENOBLE
Installateur : PCSD

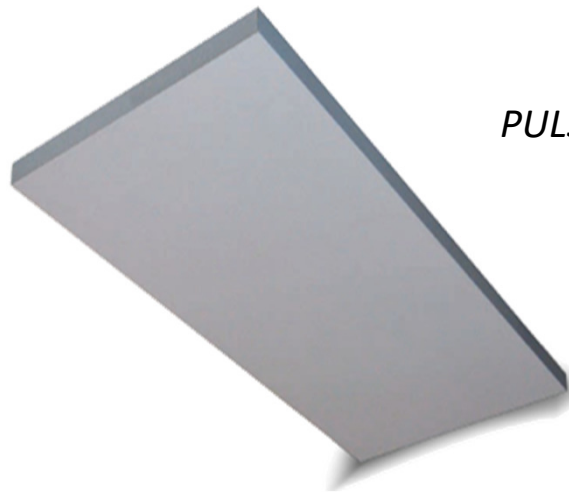

PULSAR

*Projet : IUT 2019 - QUIMPER 29
Activité : Industrie
Produit : Pulsar
Quantité : 46 ml
Période : 2021
Installateur : ELORN PLOMBERIE CHAUFFAGE*



REHABILITATION BATIMENT FORMATION NUCLEAIRE - MER 41

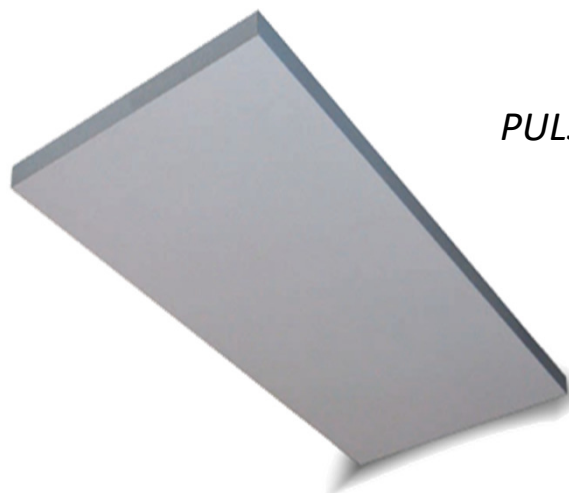

PULSAR

*Projet : Rehabilitation bâtiment formation nucléaire -
MER 41*

Activité : Industrie

Produit : Pulsar

Quantité : 46 ml

Période : 2021

BET : PROJECT INGENIERIE

Installateur : GALLOUX



DOJO CHALUS 87



DUCK-STRIP



DUCK-STRIP

Projet : DOJO CHALUS 87

Activité : Industrie

Produit : Duck-strip

Quantité : 40 ml

Période : 2020

BET : BEI

Installateur : NPMC



MAISON QUARTIER LES 3 MATS - ANGERS



DUCK-STRIP

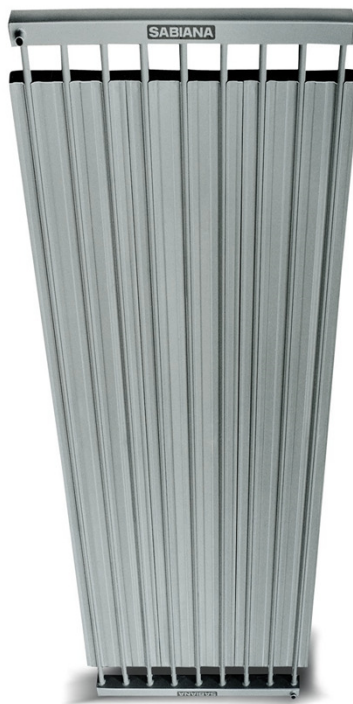

DUCK-STRIP

Projet : MAISON QUARTIER LES 3 MATS - ANGERS
Activité : Industrie
Produit : Duck-strip
Quantité : 40 ml
Période : 2021
Installateur : EIB



POLE DE VIE LA DOUA - VILLEURBANNE 69

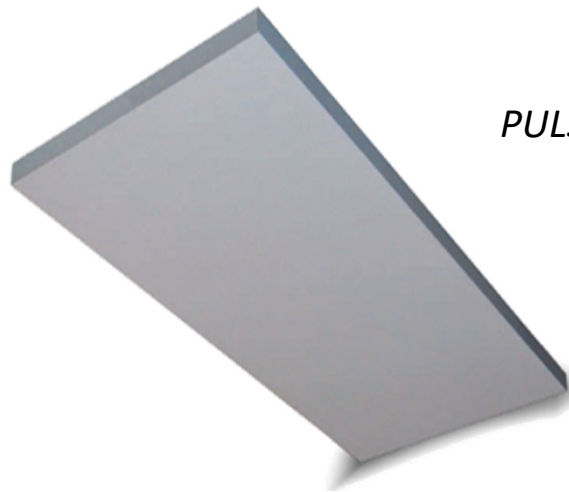

PULSAR

Projet : POLE DE VIE LA DOUA - VILLEURBANNE 69
Activité : Industrie
Produit : Pulsar
Quantité : 40 ml
Période : 2021
Installateur : CHRISTIN



CIME CENTRE D INNOVATION MINIERE - ORANO MINING - GARTEMPE



DUCK-STRIP



DUCK-STRIP

*Projet : Cime Centre d'Innovation Miniere –
Orano Mining - GARTEMPE 23
Activité : Industrie
Produit : Duck-strip
Quantité : 34 ml
Période : 2020
BET : ARTELIA B&I
Installateur : SOPCZ*



ROSSOW - GENNEVILLIERS 92



DUCK-STRIP

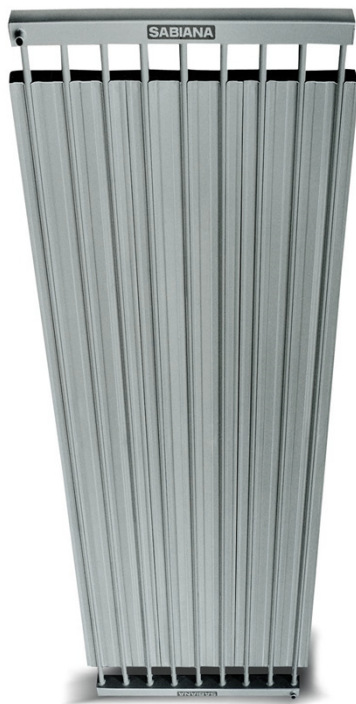

DUCK-STRIP

Projet : ROSSOW - GENNEVILLIERS 92

Activité : Industrie

Produit : Duck-strip

Quantité : 34 ml

Période : 2021

BET : BECETH

Installateur : LGC



NILAC - CLERMONT FERRAND 63

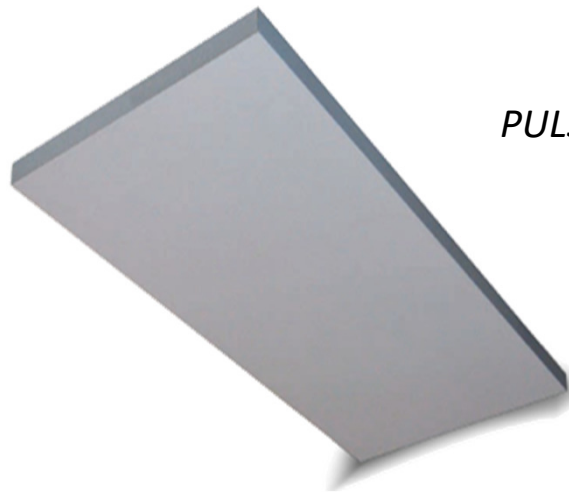

PULSAR

*Projet : NILAC - CLERMONT FERRAND 63
Activité : Industrie
Produit : Pulsar
Quantité : 32 ml
Période : 2021
Installateur : EIFFAGE ENERGIE THERMIE*



EXTENSION MECAPROTEC - MURET



DUCK-STRIP

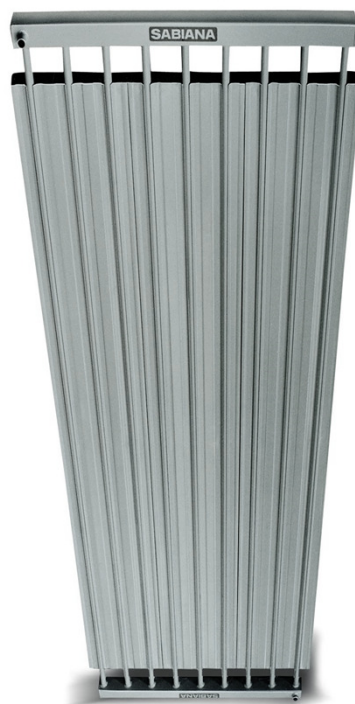

DUCK-STRIP

*Projet : Extension Mecaprotec - MURET 31
Activité : Industrie
Produit : Duck-strip
Quantité : 27 ml
Période : 2020
BET : CALOBAT
Installateur : LACLIM*



IDDAC BATIMENT BT51 - BEGLES 33

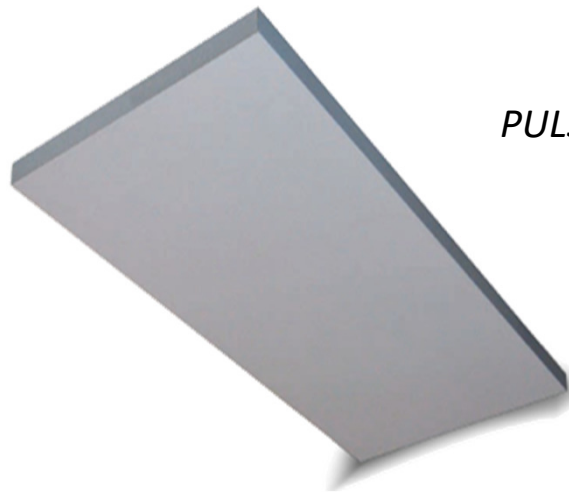

PULSAR

Projet : IDDAC BATIMENT BT51 - BEGLES 33
Activité : Industrie
Produit : Pulsar
Quantité : 23 ml
Période : 2021
BET : IG CONCEPT
Installateur : BOBION & JOANIN



RESTRUCTURATION D'UN BATIMENT INDUSTRIEL EN CENTRE DE CONFERENCE - BEAUBOURG 77

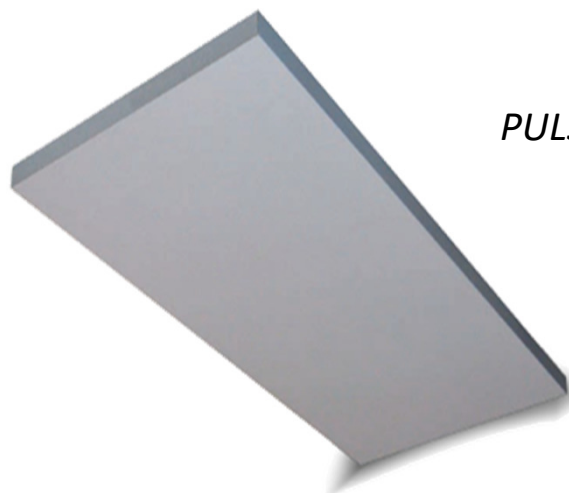

PULSAR

*Projet : Restructuration d'un bâtiment industriel en
centre de conférence - BEAUBOURG 77
Activité : Industrie
Produit : Pulsar
Quantité : 22 ml
Période : 2021
Installateur : COGECLIM*

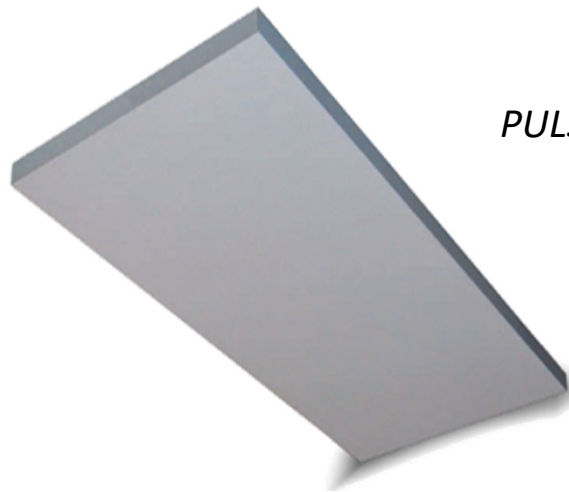

PULSAR

Projet : TECHNOFORME LUMINY - MARSEILLE 13

Activité : Industrie

Produit : Pulsar

Quantité : 18 ml

Période : 2021

BET : SEE SUD ETUDE ENGINEERING

Installateur : EITP



MANECANTERIE - ST BRIEUC

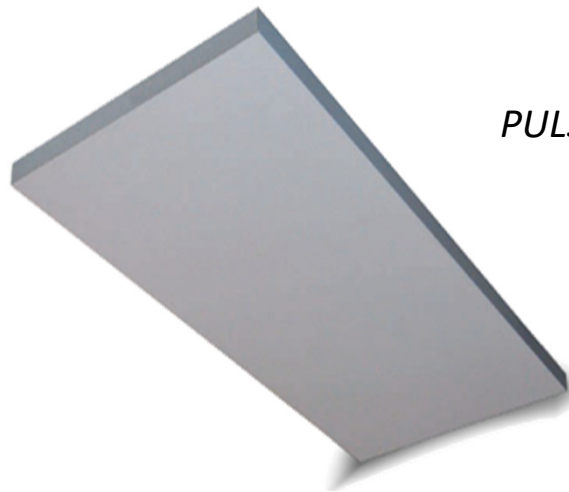

PULSAR

*Projet : MANECANTERIE - ST BRIEUC
Activité : Industrie
Produit : Pulsar
Quantité : 18 ml
Période : 2021
BET : BECOME INGENIERIE
Installateur : CSA*



AGV GDV - ISSOUDUN 36

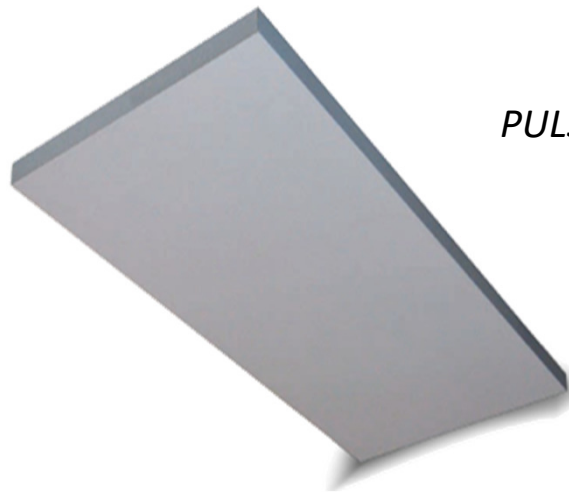

PULSAR

Projet : AGV GDV - ISSOUDUN 36
Activité : Industrie
Produit : Pulsar
Quantité : 14 ml
Période : 2020
BET : COMBIOSOL
Installateur : ACIA ENTREPRISE



BATIMENT COMMERCIALE - ST PAIR SUR MER 50



DUCK-STRIP



DUCK-STRIP

*Projet : Bâtiment Commerciale - ST PAIR SUR MER 50
Activité : Industrie
Produit : Duck-strip
Quantité : 12 ml
Période : 2021
Installateur : DOUBLET*



USINE DESPIAU CHEVALETS - GIMONT 32

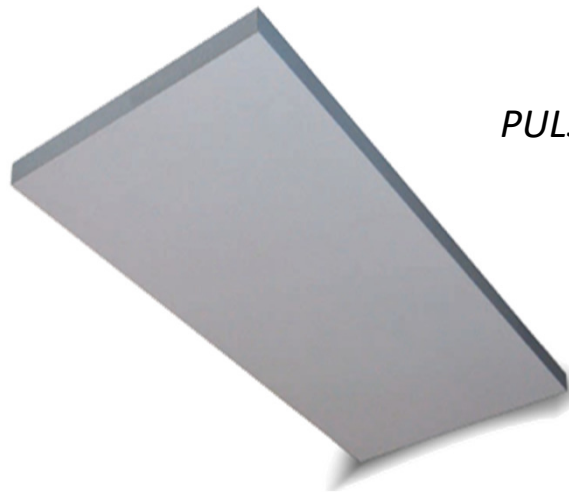

PULSAR

Projet : USINE DESPIAU CHEVALETS - GIMONT 32
Activité : Industrie
Produit : Pulsar
Quantité : 10 ml
Période : 2020
BET : SATEC INGENIERIE
Installateur : JUSTUMUS



USINE JUNGHEINRICH - VELIZY VILLACOUBLAY 78



DUCK-STRIP



DUCK-STRIP

*Projet : USINE JUNGHEINRICH - VELIZY VILLACOUBLAY
Activité : Industrie
Produit : Duck-strip
Quantité : 10 ml
Période : 2021
BET : VELLUET INGENIERIE AXYS
Installateur : ENGIE AXIMA BRY SUR MARNE*



MAPAD - RUE FRANCOIS MITTERRAND - CONCHES EN OUCHE 27

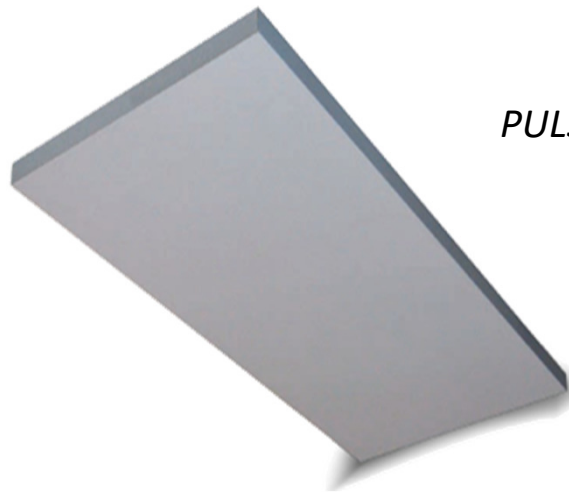

PULSAR

*Projet : MAPAD - RUE FRANCOIS MITTERRAND -
CONCHES EN OUCHE 27
Activité : Industrie
Produit : Pulsar
Quantité : 10 ml
Période : 2021
Installateur : TEMPERIA NORMANDIE*

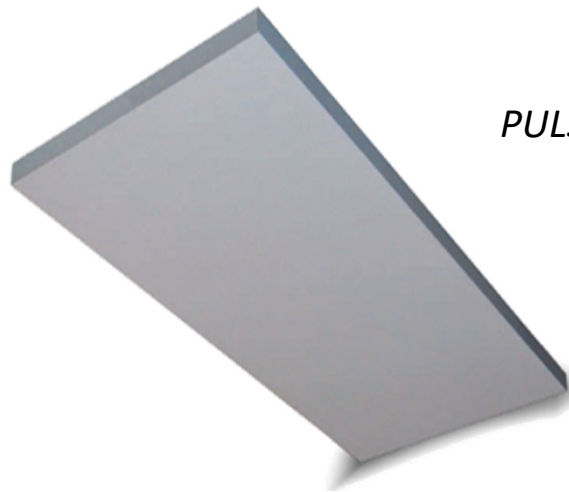

PULSAR

*Projet : LA SAGESSE – RENNES
Activité : Industrie
Produit : Pulsar
Quantité : 06 ml
Période : 2021
BET : OTEIS ISATEG
Installateur : ENGIE AXIMA*



FM LOGISTIC - ESCRANNES 45



ATLAS



ATLAS

Projet : FM LOGISTIC - ESCRANNES 45
Activité : Industrie
Produit : Aérotherme
Quantité : 54 Atlas
Période : 2020
BET : NG CONCEPT
Installateur : HERVE THERMIQUE ORLEANS



PLATEFORME KTN - DOSSIER 2018 – ST MARTIN DE CRAU 13



ATLAS



ATLAS

*Projet : PLATEFORME KTN - DOSSIER 2018 - ST
MARTIN DE CRAU 13
Activité : Industrie
Produit : Aérotherme
Quantité : 36 Atlas
Période : 2020-2021
Installateur : EIFFAGE ENERGIE THERMIE VITROLLES*



PLATEFORME LOGISTIQUE BONNARD - LA VERPILLERE



ATLAS



ATLAS

*Projet : Plateforme Logistique Bonnard –
LA VERPILLERE 38
Activité : Industrie
Produit : Aérotherme
Quantité : 28 Atlas
Période : 2020
BET : /
Installateur : AIR CF*



PLATEFORME LOGISTIQUE - VIRTUO - PORT SAINT LOUIS DU RHONE



ATLAS



ATLAS

*Projet : Plateforme Logistique - VIRTUO - PORT SAINT LOUIS DU RHONE 13
Activité : Industrie
Produit : Aérotherme
Quantité : 27 Atlas
Période : 2020
BET : RBE ROLLAND - PURE ING
Installateur : BURLINCHON*



DASSAULT AVIATION - H03 2022 – RESTRUCTURATION DU HALL 03- BIARRITZ 64



ATLAS



ATLAS

*Projet : DASSAULT AVIATION - H03 2022 –
RESTRUCTURATION DU HALL 03- BIARRITZ 64
Activité : Industrie
Produit : Aérotherme
Quantité : 19 Atlas
Période : 2021
BET : EGIS BATIMENT SUD OUEST
Installateur : ENGIE COFELY – BAYONNE 64*



VIAPOST - ST DIDIER 01



ELECTRAMATIC



ELECTRAMATIC

Projet : VIAPOST - ST DIDIER 01

Activité : Industrie

Produit : Aérotherme

Quantité : 34 Electramatic

Période : 2021

Installateur : VINCI FACILITIES



HANGAR H5 LE BOURGET 93



COMFORT



COMFORT

Projet : HANGAR H5 LE BOURGET 93

Activité : Industrie

Produit : Aérotherme

Quantité : 24 Comfort

Période : 2021

Installateur : PROTHERM



APM ARDEC - CHAMPAGNOLE 39



COMFORT



COMFORT

Projet : APM ARDEC - CHAMPAGNOLE 39
Activité : Industrie
Produit : Aérotherme
Quantité : 16 Comfort
Période : 2021
Installateur : EIMI



PLATEFORME PROLOGIS ET SYLVANIA – MOISSY CRAMAYEL 77



ATLAS



ATLAS

*Projet : PLATEFORME PROLOGIS ET SYLVANIA - MOISSY
CRAMAYEL 77
Activité : Industrie
Produit : Aérotherme
Quantité : 15 Atlas
Période : 2021
Installateur : ERI*



FAURECIA INDUSTRIE - HÉNIN BEAUMONT 62



MELTEMI

NO-STRAT

ATLAS



NO-STRAT



MELTEMI

ATLAS



Projet : FAURECIA INDUSTRIE - HÉNIN BEAUMONT 62
Activité : Industrie
Produit : Aérotherme
Quantité : 3 Atlas & 10 No-Strat & 2 Meltemi
Période : 2021
Installateur : BAIL



NESTLE - PROJET BEST - BOUE



AIX



ATLAS

Projet : Nestlé - Projet Best - BOUE 02

Activité : Industrie

Produit : Aérotherme

Quantité : 8 AIX

Période : 2020

BET : PINGAT INGENIERIE

2A DISTRIBUTION SOMATEC

Installateur : CEF AVELIN



L'HEXAGONE LA GUERCHE DE BRETAGNE



ATLAS



ATLAS

*Projet : L'HEXAGONE LA GUERCHE DE BRETAGNE
Activité : Industrie
Produit : Aérotherme
Quantité : 8 Atlas
Période : 2020
Installateur : ROQUET G.*



BHD NORT SUR ERDRE 44



ELECTRAMATIC

Projet : BHD NORT SUR ERDRE 44

Activité : Industrie

Produit : Aérotherme

Quantité : 6 Electramatic

Période : 2020

BET : ECLIMAI OUEST

Installateur : ROQUET G.



USINE PERNOD RICARD - MARSEILLE



COMFORT



Projet : Usine Pernod Ricard – MARSEILLE 13
Activité : Industrie
Produit : Aérotherme
Quantité : 6 Comfort
Période : 2014
BET : BERTIN PHILIPPE
Installateur : ATC MARSEILLE



MICHELIN CATAROUX B62 ET B63



ATLAS



COMFORT



COMFORT



ATLAS

*Projet : MICHELIN CATAROUX B62 ET B63
Activité : Industrie
Produit : Aérotherme
Quantité : 5 Comfort & 1 Atlas
Période : 2021
BET : R3I
Installateur : SANTERNE THERMIQUE & CLIMATIQUE*



ENTREPOT AMAZON BOULEVARD NEY PARIS - 75



COMFORT



COMFORT

*Projet : ENTREPOT AMAZON BOULEVARD NEY PARIS
Activité : Industrie
Produit : Aérotherme
Quantité : 5 Comfort
Période : 2021
Installateur : AIR SEREIN*



VIRTUO - CONSTRUCTION BATIMENT LOGISTIQUE - MIRIBEL 01



ATLAS



ATLAS

*Projet : VIRTUO - Construction Bâtiment Logistique -
MIRIBEL 01*

Activité : Industrie

Produit : Aérotherme

Quantité : 4 Atlas

Période : 2020

BET : RBE ROLLAND – PURE ING

Installateur : HERVE THERMIQUE BRIGNAIS



MICHELIN LADOUX - CREATION DE 4 PADDOCKS - CEBAZAT 63



ELECTRAMATIC

*Projet : MICHELIN LADOUX - CREATION DE 4 PADDOCKS -
CEBAZAT 63
Activité : Industrie
Produit : Aérotherme
Quantité : 4 Electramatic
Période : 2021
BET : INGEROP
Installateur : CAU*



CIS BEAUSSAIS SUR MER 22



ATLAS



ATLAS

Projet : CIS BEAUSSAIS SUR MER 22
Activité : Industrie
Produit : Aérotherme
Quantité : 3 Atlas
Période : 2020
BET : ARMOR INGENIERIE
Installateur : EREO



TANNERIE DU PUY - RENOVATION TRANCHE 1 - CHADRAC 43



AIX

*Projet : TANNERIE DU PUY - RENOVATION TRANCHE 1 -
CHADRAC 43
Activité : Industrie
Produit : Aérotherme
Quantité : 4 Aix
Période : 2021
BET : CETEB INGENIERIE INGENIUL
Installateur : REY*



LYONNAISE DE SALAISON



ATLAS



ATLAS

*Projet : LYONNAISE DE SALAISON
Activité : Industrie
Produit : Aérotherme
Quantité : 3 Atlas
Période : 2021
Installateur : IFC ST PRIEST 69*



ECAM FACTORY



COMFORT



COMFORT

*Projet : ECAM FACTORY
Activité : Industrie
Produit : Aérotherme
Quantité : 2 Comfort
Période : 2020
BET : STREM
Installateur : NOVELIO*



NEXTER BATIMENT VEHICULES BLINDES - ROANNE



ATLAS



ATLAS

Projet : Nexter Bâtiment Véhicules Blindes - ROANNE 42
Activité : Industrie
Produit : Aérotherme
Quantité : 2 Atlas
Période : 2020
BET : STREM
Installateur : HERVE THERMIQUE ROANNE



SILVATRIM VALREAS 84



ELECTRAMATIC



ELECTRAMATIC

Projet : SILVATRIM VALREAS 84

Activité : Industrie

Produit : Aérotherme

Quantité : 1 Electramatic

Période : 2020

Installateur : SNEF VALENCE



EMS - SAUMUR 49



SkyStar



CRC

*Projet : EMS - SAUMUR 49
Activité : Industrie
Produit : Ventilo
Quantité : 6 CRC & 16 SkyStar
Période : 2021
Installateur : MISSENARD QUINT B*



MARENDA LACAN ANTIBES 06



CRC

*Projet : MARENDA LACAN ANTIBES 06
Activité : Industrie
Produit : Ventilo
Quantité : 132 CRC
Période : 2021
Installateur : S2J CONCEPT CLIM*



TAM - MARSEILLE

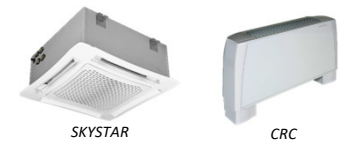

Projet : TAM – MARSEILLE 13
Activité : Industrie
Produit : Ventilo
Quantité : 35 CRC & 10 Skystar
Période : 2011
BET : /
Installateur : SNEF MARSEILLE



DASSAULT - ARGONAY 74

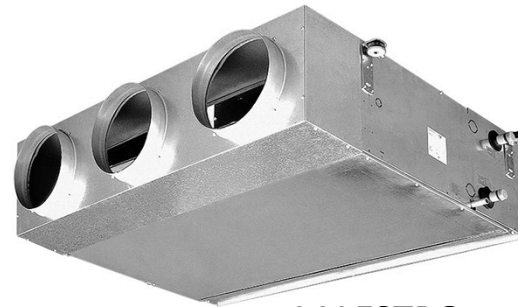

MAESTRO

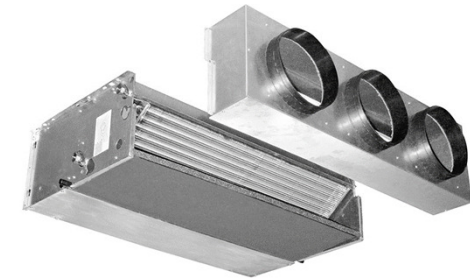

CRSL



CRC

Projet : DASSAULT - ARGONAY 74
Activité : Industrie
Produit : Ventilo
Quantité : 15 CRC & 22 CRSL & 5 Maestro
Période : 2021
BET : BEG
Installateur : HERVE THERMIQUE ORLEANS



SCI CADRAN - TOSSIAT 01

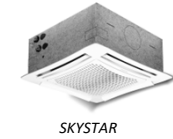

SkyStar

*Projet : SCI CADRAN - TOSSIAT 01
Activité : Industrie
Produit : Ventilo
Quantité : 35 SkyStar
Période : 2020
Installateur : JOSEPH*



GTL - BORDEAUX 33



SkyStar

*Projet : GTL - BORDEAUX 33
Activité : Industrie
Produit : Ventilo
Quantité : 20 SkyStar
Période : 2021
Installateur : JAMOT*

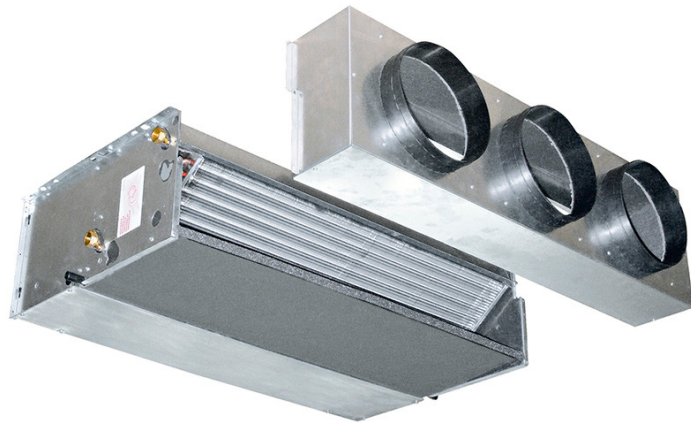
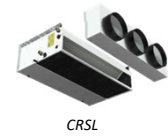

CRSL

Projet : SCI BMA - PERCY EN NORMANDIE 50
Activité : Industrie
Produit : Ventilo
Quantité : 9 CRSL
Période : 2020
BET : /
Installateur : BELLENGER



IDEA OPTICAL – LANNION



ATLAS



DUCK-STRIP



NO-STRAT

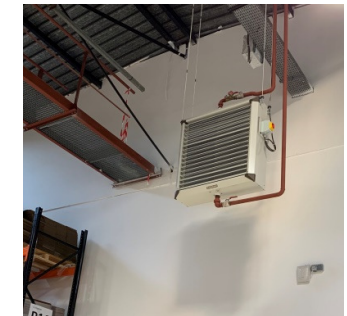
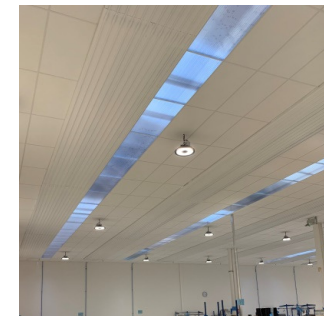

Projet : Bâtiment Industriel W4 – LANNION 22
Activité : Fabrication de câbles de fibres optiques
Produit : Duck-Strip & No-Strat & Atlas
Quantité : 624 ml & 7 No-Strat
Période : 2019
BET : BIE CONCEPTION
Installateur : ROUSSEAU BREST



UIMM - VITRE



JANUS



DUCK-STRIP

DUCK-STRIP

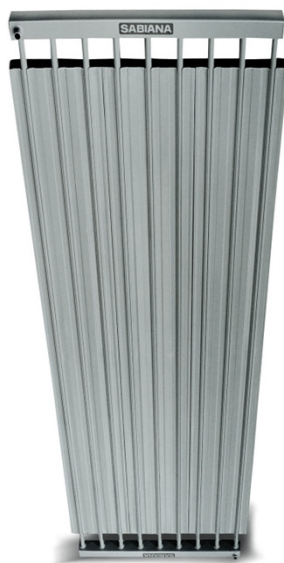

Janus

*Projet : UIMM - VITRE
Activité : Industrie
Produit : Duck-Strip & Aérotherme
Quantité : 249 ml & 10 Janus
Période : 2011
Installateur : DESSAIGNE*



BATIMENT INDUSTRIE - ANTIGNY



COMFORT



ATLAS



DUCK-STRIP

DUCK-STRIP



Atlas



COMFORT

*Projet : Bâtiment Industrie – ANTIGNY 85
Activité : Industrie
Produit : Duck-Strip & Aérotherme
Quantité : 186 ml & 7 Atlas & 5 Comfort
Période : 2020
BET : ACE
Installateur : CIGEC*



AIRTECH HALL 6 - EXTENSION DU SITE - DIFFERDANGE - LU



ATLAS



DUCK-STRIP

DUCK-STRIP

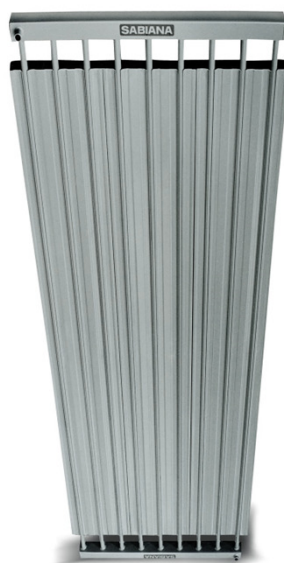

Atlas

Projet : Airtech Hall 6 - Extension Du Site - Differdange LU

Activité : Industrie

Produit : Duck-Strip & Aérotherme

Quantité : 176 ml & 3 Atlas

Période : 2020

BET : MERSCH ET SHIMITZ

Installateur : GENISTA



ADEO - RONCHIN



ATLAS



DUCK-STRIP

DUCK-STRIP

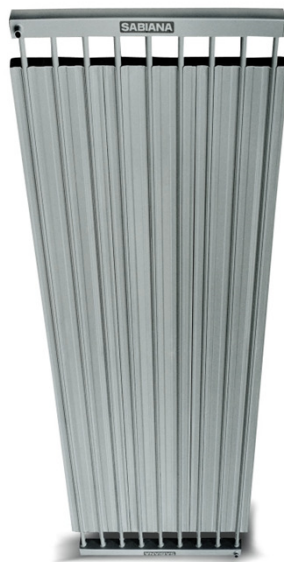

Atlas

Projet : ADEO - RONCHIN

Activité : Industrie

Produit : Duck-Strip & Aérotherme

Quantité : 132 ml & 1 Atlas

Période : 2021

Installateur : SANTERNE FLUIDES - HAUBOURDIN



TECHN HOM3 - TANDEM - LOCAUX IMPRIMERIE SCHRAAG BAT 9 - BELFORT 90



ATLAS



DUCK-STRIP

DUCK-STRIP



Atlas

*Projet : TECHN HOM3 - TANDEM - LOCAUX IMPRIMERIE
SCHRAAG BAT 9 - BELFORT 90*

Activité : Industrie

Produit : Duck-Strip & Aérotherme

Quantité : 78 ml & 3 Atlas

Période : 2021

BET : ENEBAT THERMIQUE

Installateur : MDTE



CARBOGEN - RIOM 2



ATLAS



CRSL

CRSL

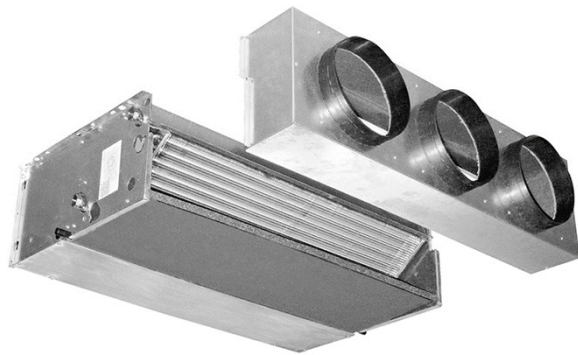

Atlas

Projet : CARBOGEN - RIOM 2

Activité : Industrie

Produit : Aérotherme & Ventilateur-convecteur

Quantité : 6 Atlas & 46 CRSL

Période : 2021

Installateur : SPIE CEBAZAT



PROJET ANTARES - BATIMENT DE PRODUCTION POUR BIAH - JONAGE 69

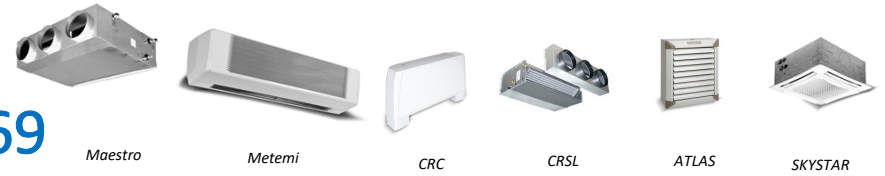

Atlas



CRC



Meltemi

SkyStar

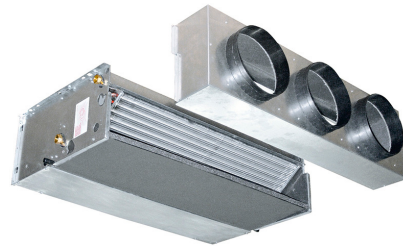

CRSL

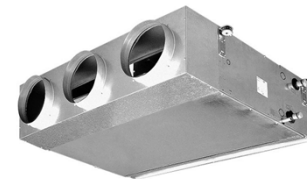

Maestro

Projet : PROJET ANTARES - BATIMENT DE PRODUCTION POUR BIAH - JONAGE 69

Activité : Industrie

Produit : Aérotherme & Ventilo-convecteur

Quantité : 3 Atlas & 15 SkyStar & 3 CRSL & 1CRC & 18

Maestro & 9 Meltemi

Période : 2020

Installateur : SPIE BRON